

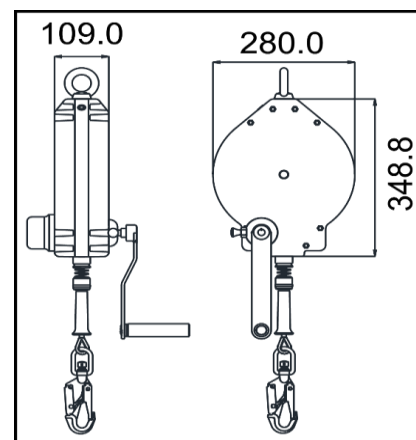











# KALYPSO



<b>HS CODE</b>
84798997
<b>CARTON SIZE / PCS.</b>
60 x 36 x 34.5 cm / 1
<b>AET N°2777/14354-01/E02-01</b>
<b>Satra Technology Europe Ltd., N° 2777,</b> Bracetown Business Park, Clonee, Dublin, D15YN2P, Ireland
<b>MODULE D FI14/14003.01</b>
<b>SGS Fimko Oy, N°0598</b> Takomotie 8, 00380 HELSINKI, Finland
<b>AET (UKCA) N°AB0321/16090-01/E01-01</b>
<b>Satra Technology Centre, N°0321</b> Wyndham Way, Telford Way, Kettering Northamptonshire, NN16 8SD, United Kingdom
<b>MODULE D 11 IN14/14003</b>
<b>SGS United Kingdom Ltd., N°0120</b> Unit 202B, Worle Parkway, Weston-super-Mare, BS22 6WA, United Kingdom
<b>ACKNOWLEDGEMENT OF RECEIPT N°3975/1/2018 (ATEX)</b>
<b>Technická Inšpekcia, a.s. N°1354</b> Trnavská cesta 56, 821 01 Bratislava, Slovenská Republika

REF.	FA 20 401 30	FA 20 401 30S
LG.  KG	30 m	
CE	EN 360:2002, EN 1496:2017 Class B	
MAT. 	Polyamide 6 - 30% fiber glass	
	STEEL Ø 4.5 mm	INOX Ø 4.5 mm
	FA 50 101 17 / FA 50 203 20 with fall indicator	FA 50 101 17 / stainless steel connector with fall indicator
	x2	
R(kN)	12 kN	
	NO	
+	(1) ATEX Directive 2014/34/UE $\langle \text{Ex} \rangle$ II 2 G Exh IIC T6 Gb (2) FA 60 001 02, FA 60 101 01	
	14.80 KG	

LG.  KG	MAT. 		
Longueur Poids maxi utilisateur Length Max. user weight Longitud Peso máximo del usuario Lunghezza Peso Max. dell'utente Länge Höchstgewicht des Benutzers	Matière carter / câble Material of casing / wire rope Material cárter / cable Material dei carter / Cavo Material Gehäuse / Seil	Matière connecteur haut / connecteur bas Material of top connector / bottom connector Material conector alto / conector bajo Materiale connettore alto / connettore basso Material oberes / unteres Verbindungselement	Nombre d'émerillons Number of swivels Cantidad de eslabones giratorios Numero di tornichetti Anzahl der Wirbel
	+	+	+
Homologué pour le travail à proximité d'arêtes vives Approved for work near sharp edges Homologado para trabajo cerca de aristas vivas Omologato per lavoro in prossimità di spigoli vivi Zugelassen für Arbeiten in der Nähe scharfer Kanten	(1) Point fort Key feature Ventaja principal Punti forti Produktvorteil	(2) À utiliser avec To be used with Para usar con Ad essere utilizzato con Verwendet werden soll mit	